

HIGH PRESSURE CLEANERS



PAGE INDEX

1. MD Series
2. MP 10
3. QMD Series
4. XMT 1000

PRACTICAL INFO.

Every product is delivered with an assortment of different sized nozzles shown in the performance graphs below each product

READ PRODUCT CODE

MODEL	NUMBER OF NOZZLES	NOZZLE SIZE
MP 10	2	2

IMPORTANT TERMS

HT - High temperatures
F - Explosion proof
OT - Oil tolerant

TerTech

MD SERIES

High Pressure Cleaner

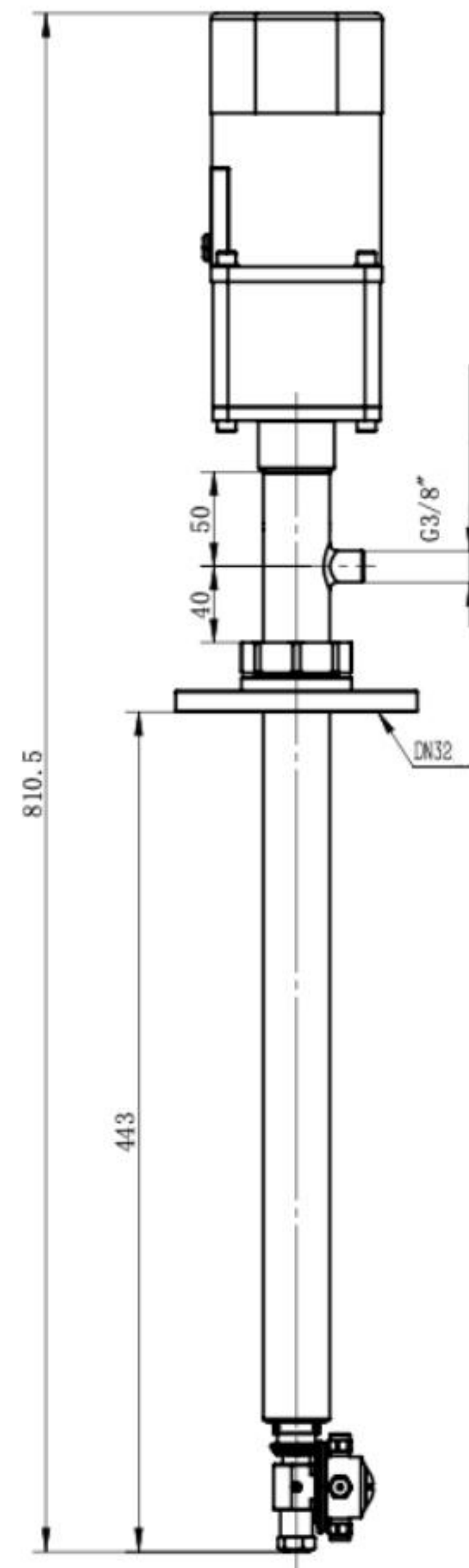

								
3-95c°	3-100b	1-2m	50-100mm	2	EXC.	0,6 - 10,5m³/h	3/4 BSPF	8-12 kg
TEMPERATURE	PRESSURE	TANK DIAMETER	MIN. HATCH SIZE	NOZZLES	NOZZLE SIZE	10- 175 L/MIN	CONNECTION	WEIGHT

DESIGN FEATURES

- Driven by DC24V/ 60W electric motor with external gears. The motor is IP65 and achieves 1400 r/pm
- Provides 360° impact coverage
- Liquid-saving dynamic seal. Only 3% waste
- Compact build ideal for small openings
- Mounting angle: Any direction
- Body: 316 SS

SPRAY PATTERN

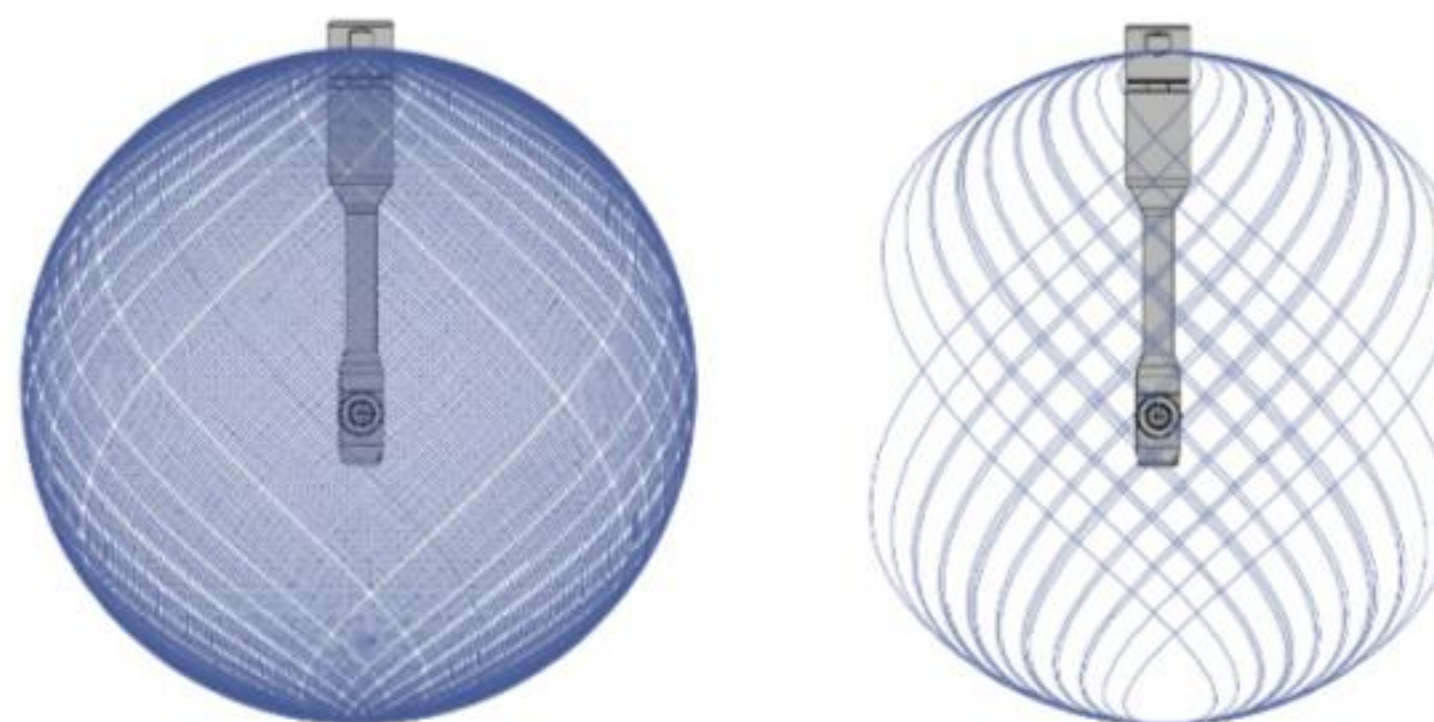

APPLICATION

- Cleaning of large containers
- Commonly used in food, shipping and process industries
- Cleaning with foam/water for steam sterilisation
- Able withstand harsh chemicals

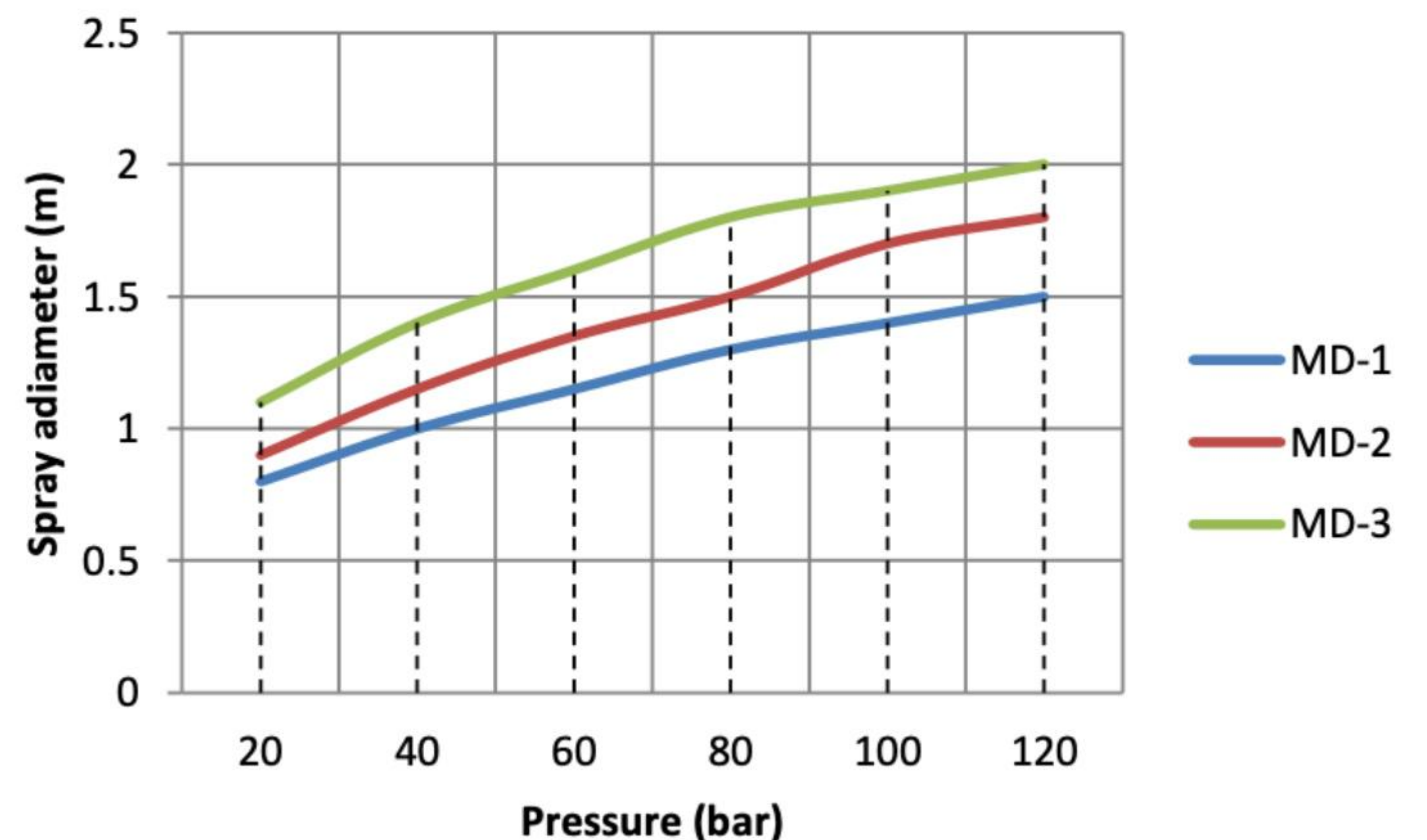
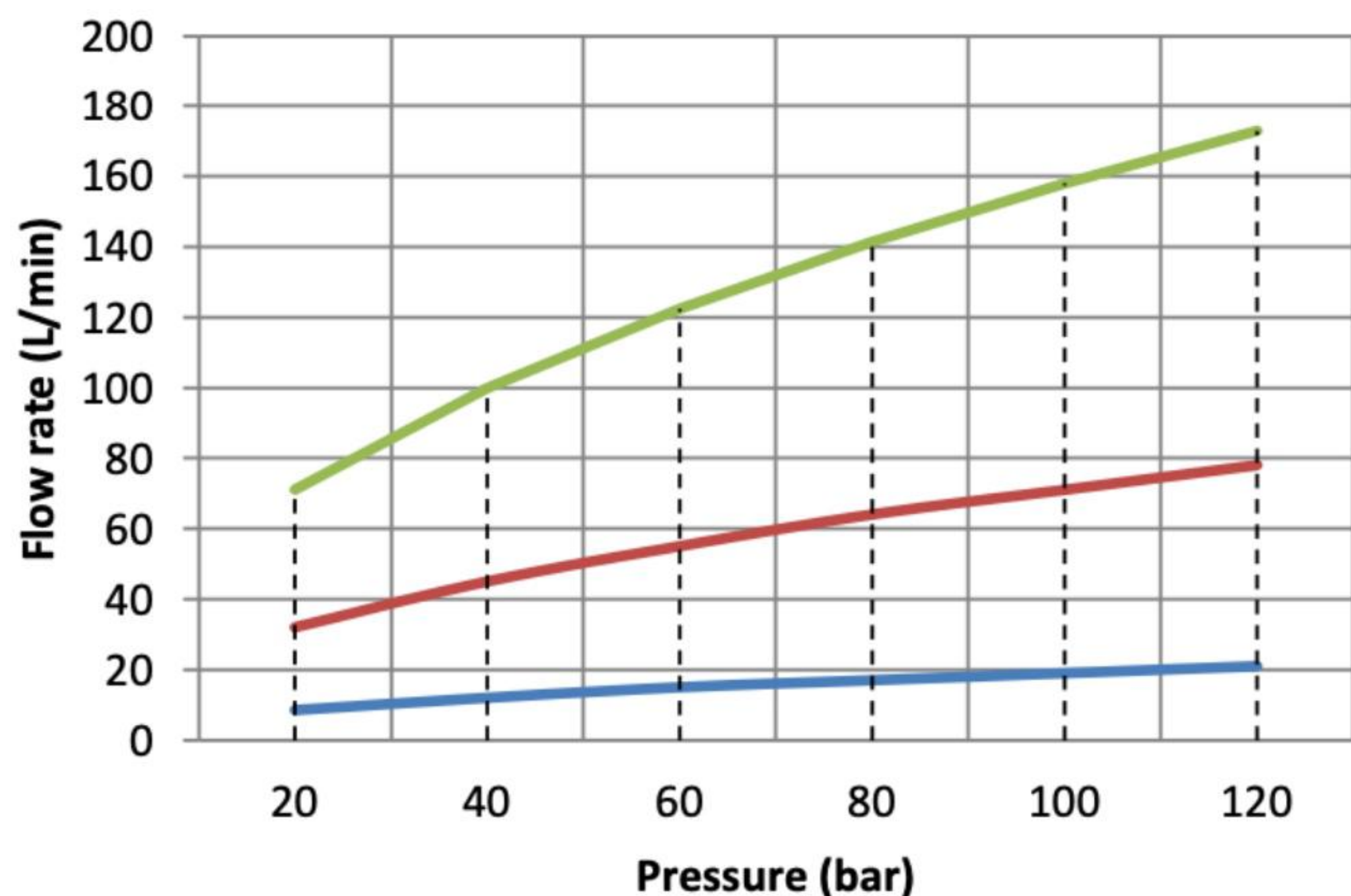

TerTech

MP10

High Pressure Cleaner

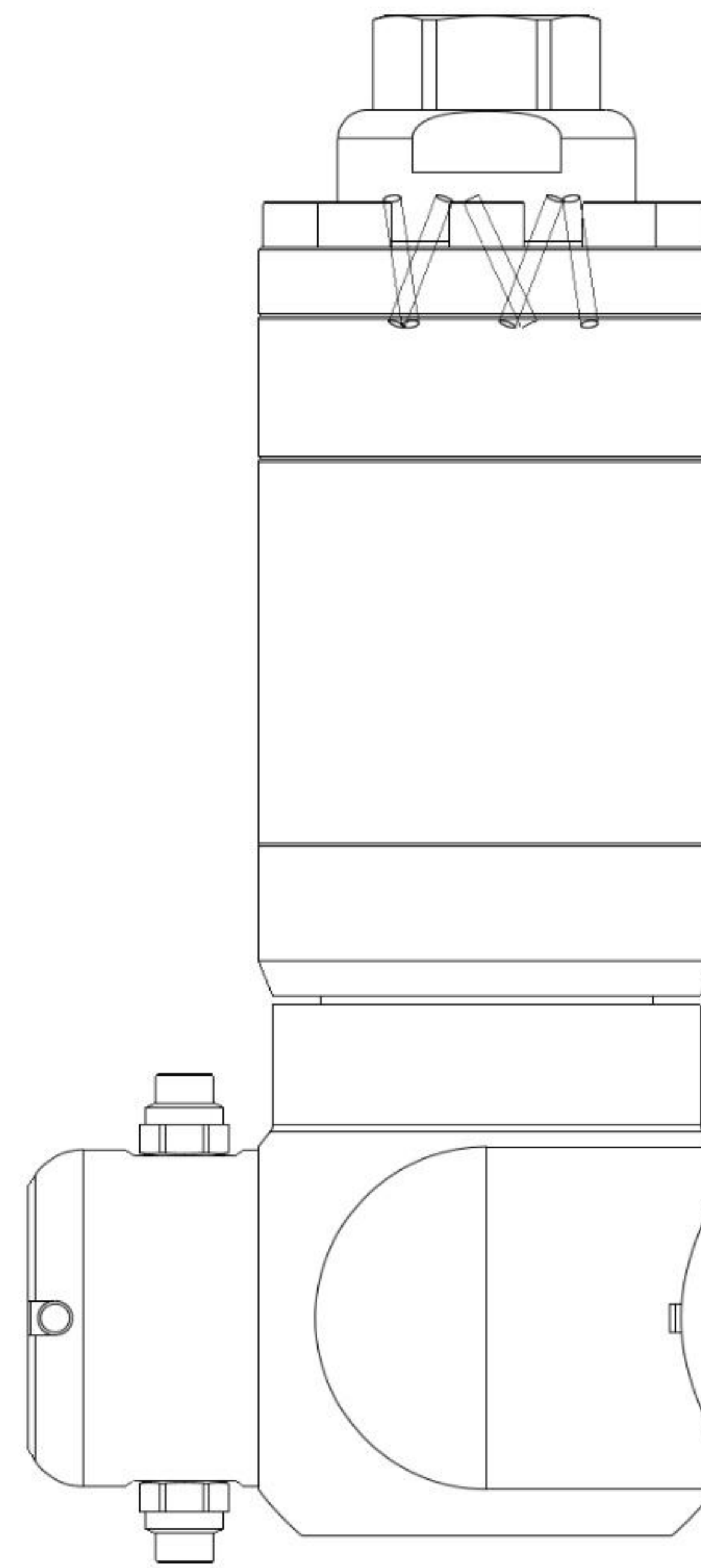

3-90c°

TEMPERATURE



40-140b

PRESSURE



1-10m

TANK DIAMETER



56-79mm

MIN. HATCH SIZE



4

NOZZLES

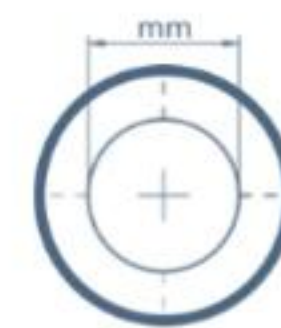

EXC.

NOZZLE SIZE



1,5-4,5m³/h

25-75 L/MIN



3/4 BSPF

CONNECTION



kg

9 kg

WEIGHT

DESIGN FEATURES

- High performance at high pressures
- Driven and lubricated by the washing fluid
- Controlled rotation with low wear sliding bearings
- Mounting angle: Any direction
- Body: 316 SS
- Gaskets/bushings: 316 SS

SPRAY PATTERN

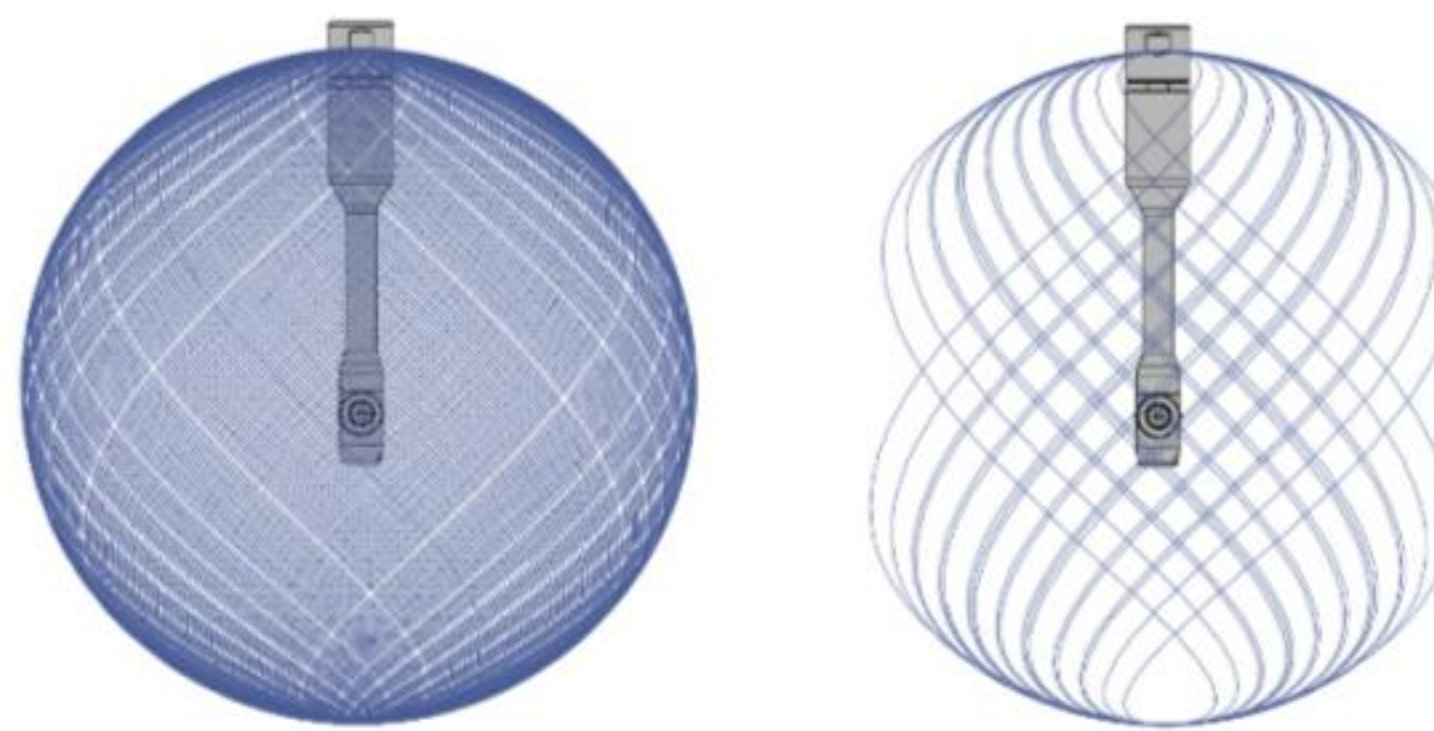

APPLICATION

- Cleaning of large containers
- Commonly used in food, shipping and process industries
- Cleaning with foam/water for steam sterilisation
- Able withstand harsh chemicals

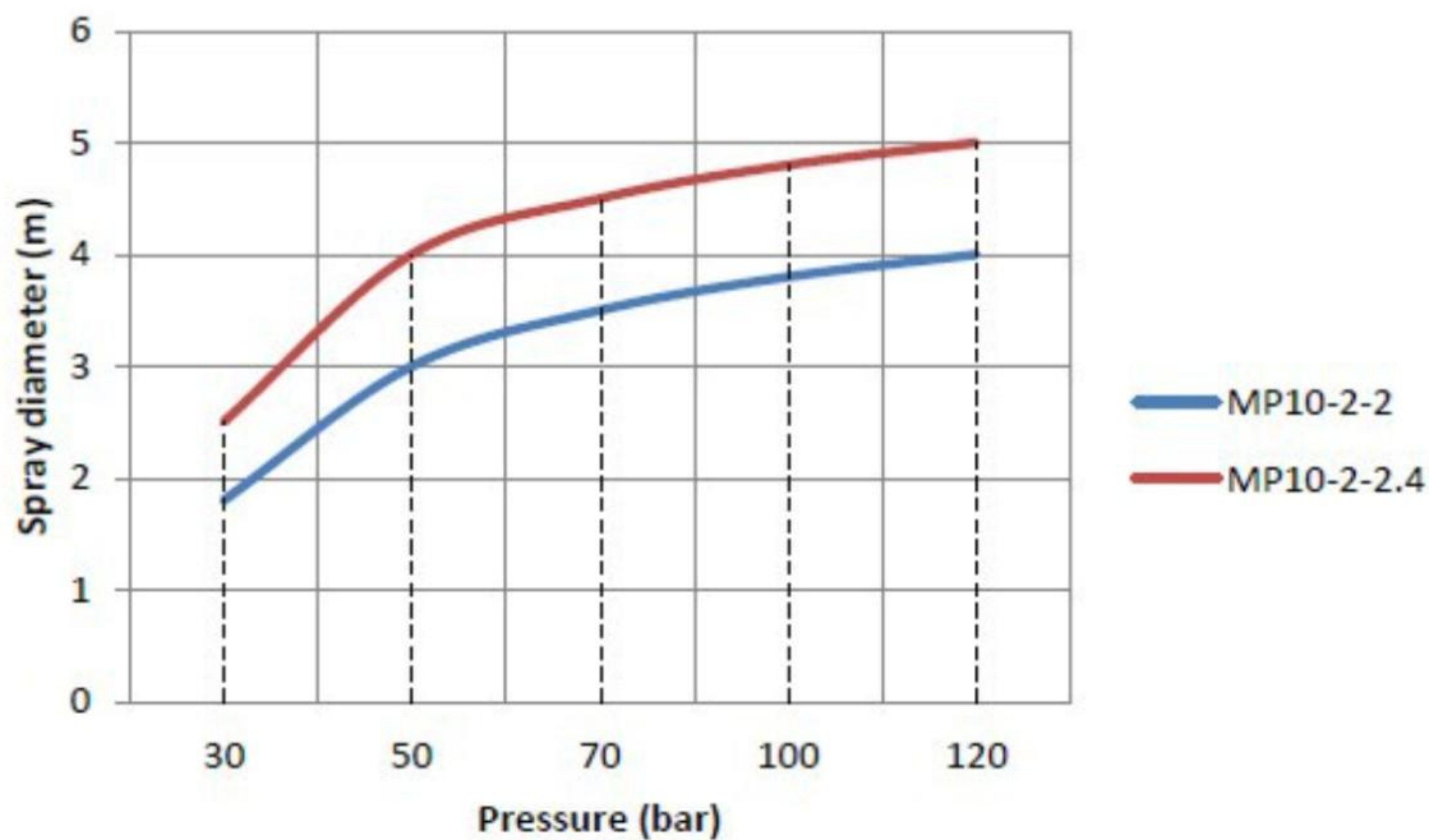
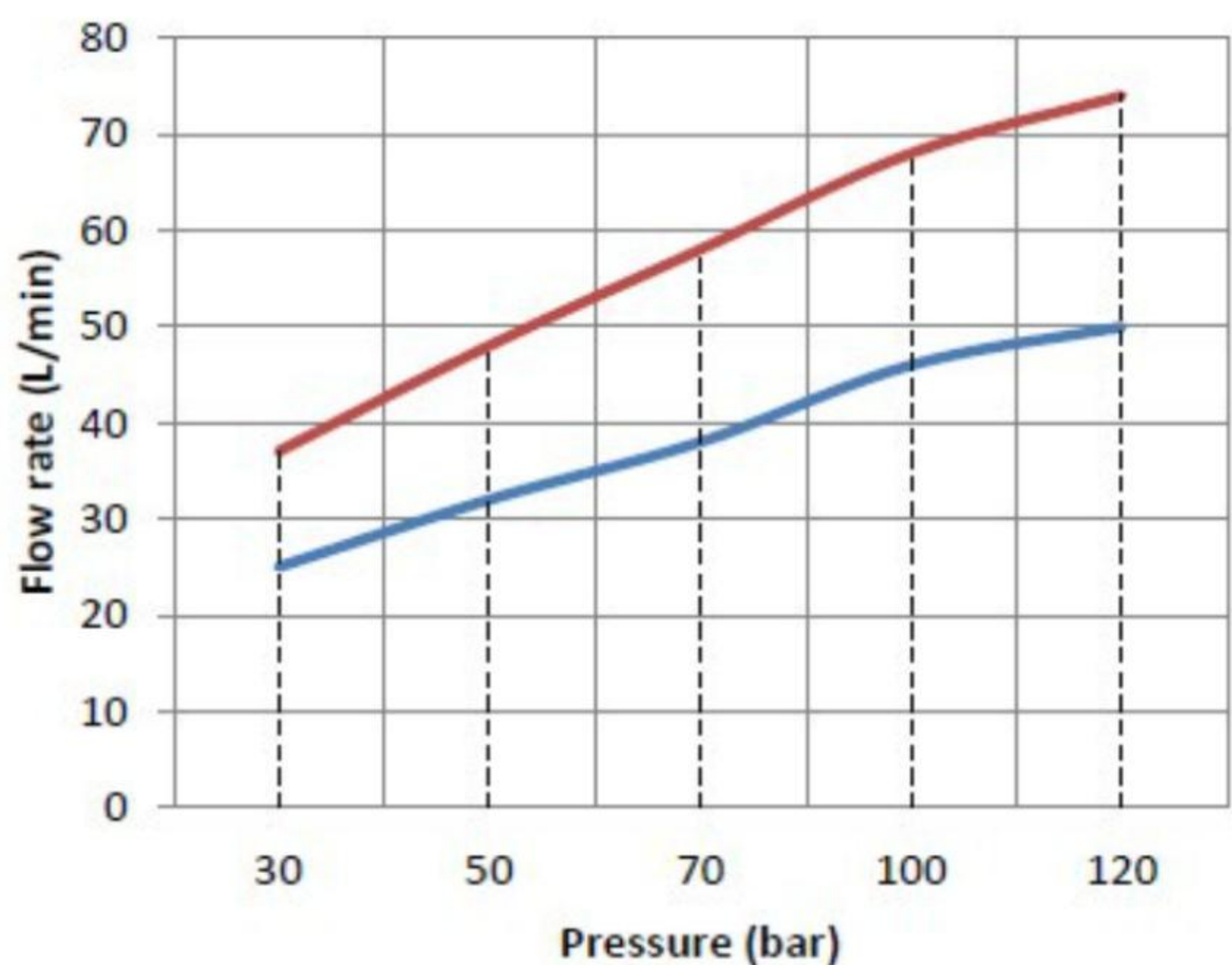

QMD SERIES

High Pressure Cleaner



								
3-95c° TEMPERATURE	3-100b PRESSURE	1-2m TANK DIAMETER	50-100mm MIN. HATCH SIZE	2 NOZZLES	EXC. NOZZLE SIZE	0,6 - 1,2m³/h 10- 175 L/MIN	3/4 BSPF CONNECTION	8-12 kg WEIGHT

DESIGN FEATURES

- Driven by pneumatic motor with external gears.
- Provides 360° impact coverage
- Liquid-saving dynamic seal. Only 3% waste
- Compact build ideal for small openings
- Mounting angle: Any direction
- Body: 316 SS

SPRAY PATTERN

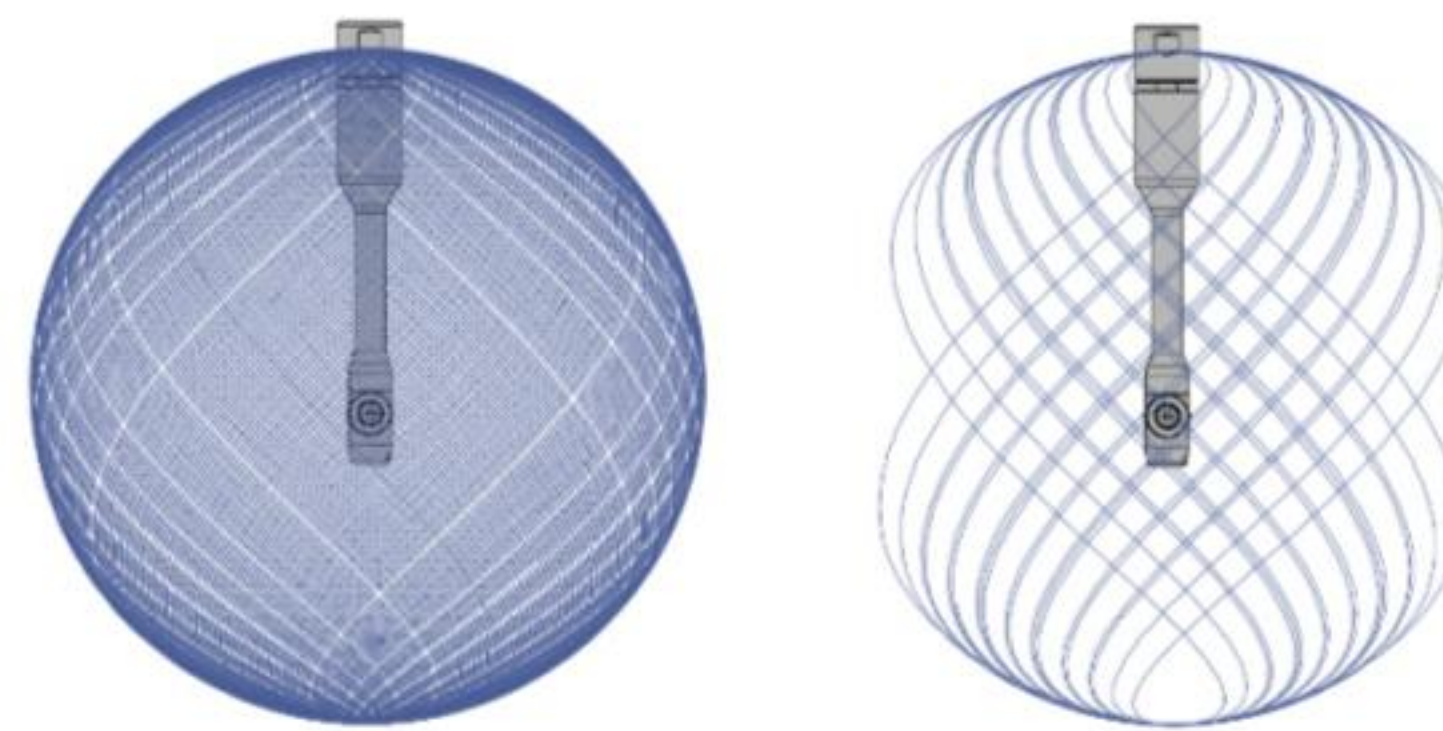

APPLICATION

- Cleaning of large containers
- Commonly used in food, shipping and process industries
- Cleaning with foam/water for steam sterilisation
- Able withstand harsh chemicals

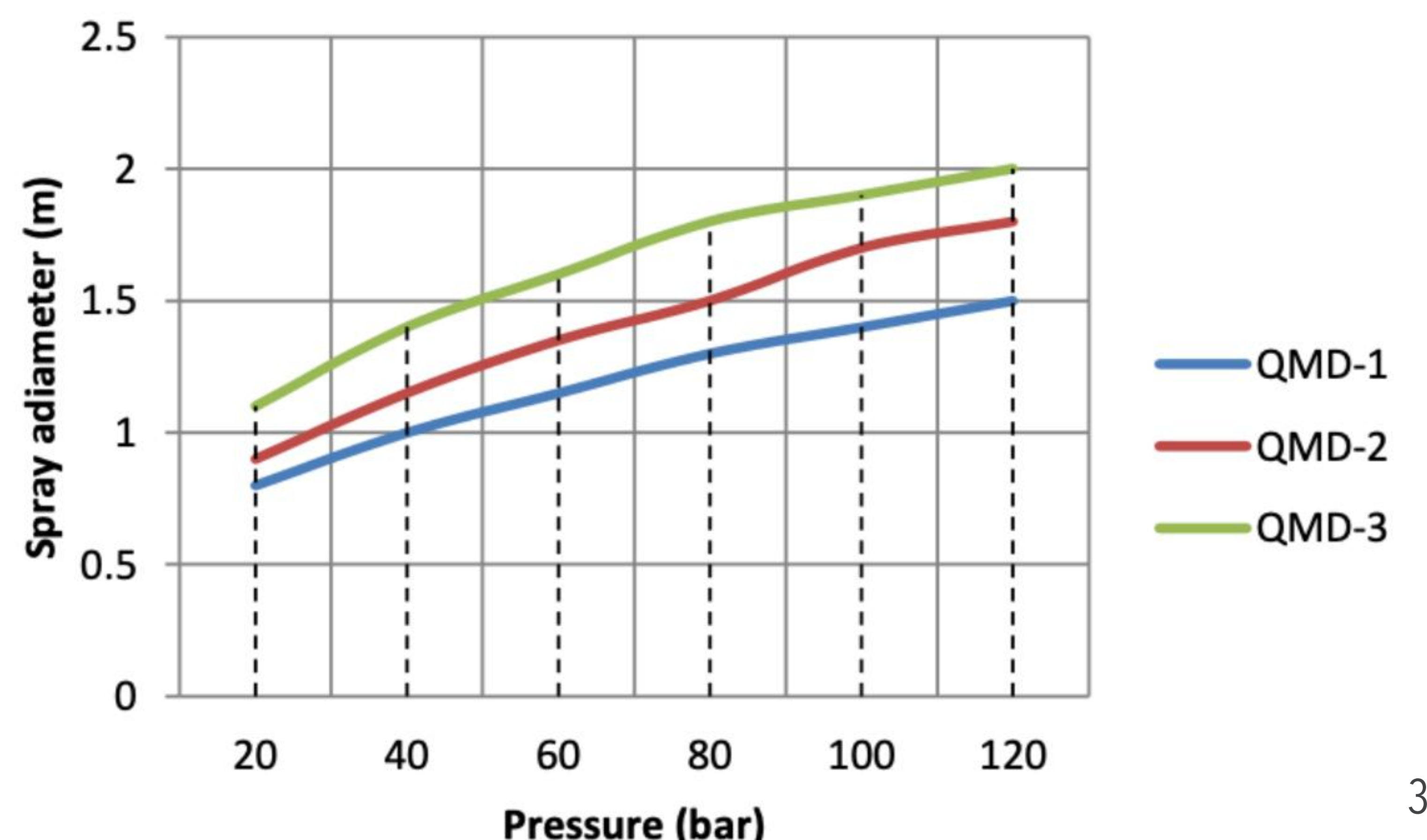
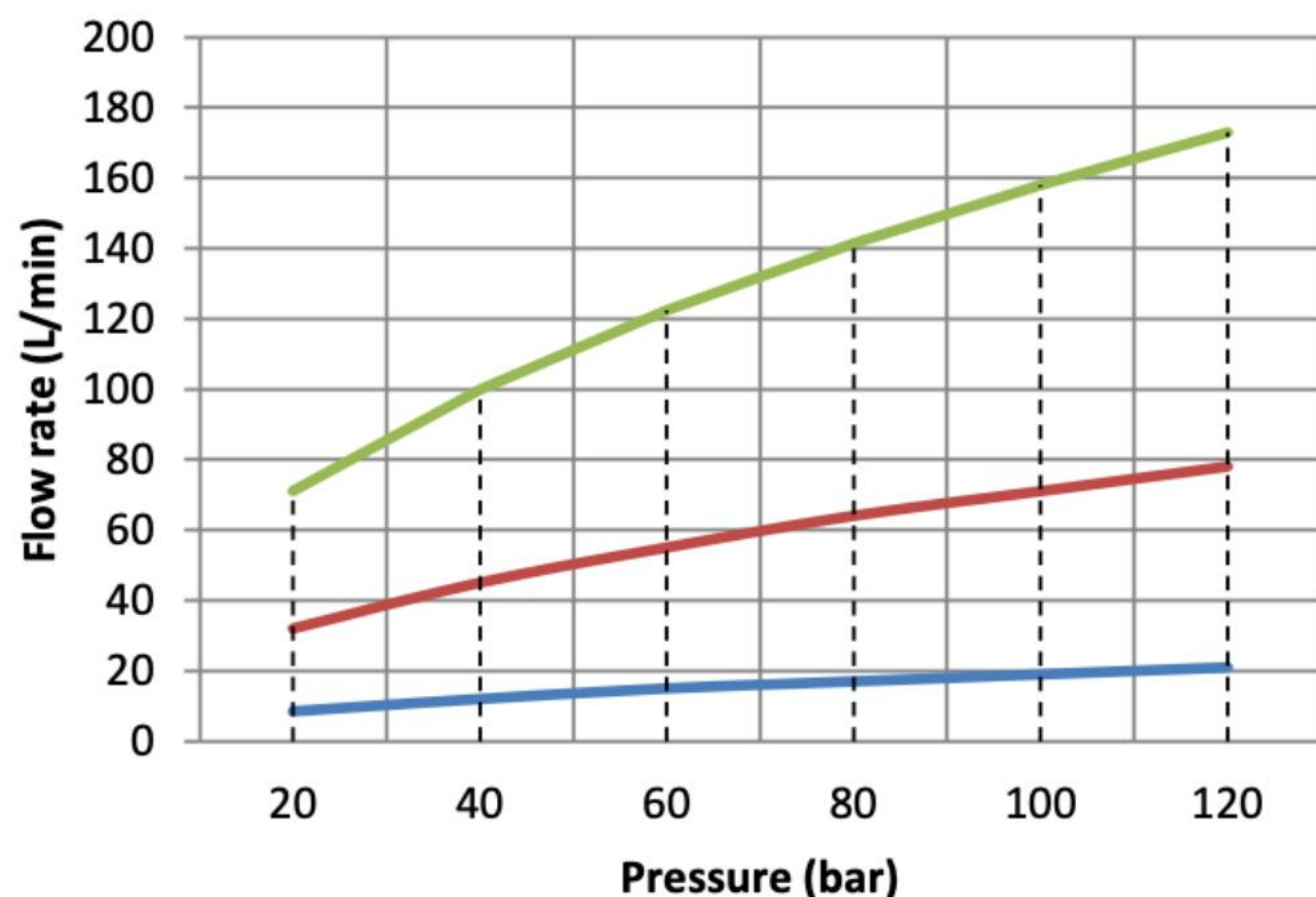

TerTech

XMT 1000

High Pressure Cleaner



3-140c°
TEMPERATURE



3-100b
PRESSURE



1-1,5m
TANK DIAMETER



50-100mm
MIN. HATCH SIZE



4
NOZZLES



EXC.
NOZZLE SIZE



0,4 - 3,6m³/h
7- 60 L/MIN



3/8 BSPF
CONNECTION



8-12 kg
WEIGHT

DESIGN FEATURES

- Driven by external motor.
- Integrated suction system for removing dirty water
- Provides 360° impact coverage
- Compact build ideal for small openings
- Mounting angle: Any direction
- Body: 304/316 SS

SPRAY PATTERN

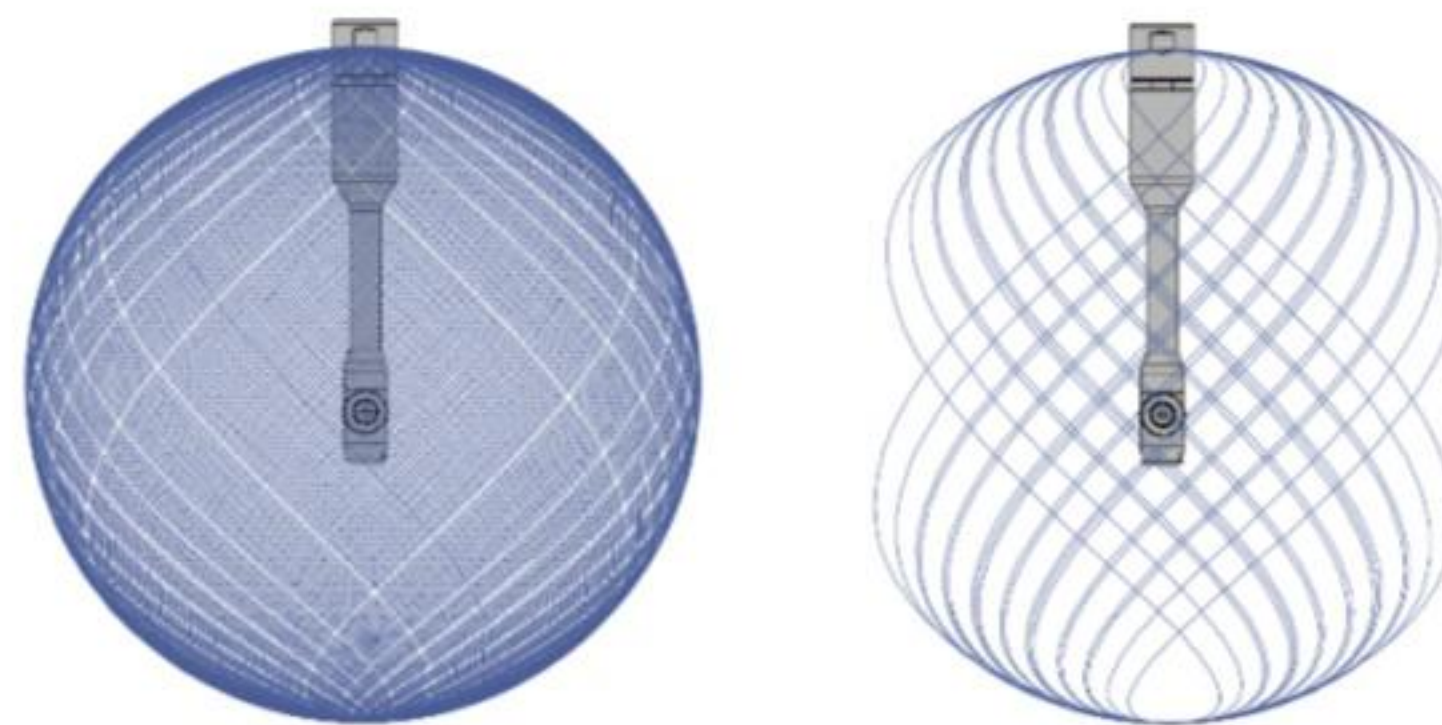

APPLICATION

- Cleaning of large containers
- Commonly used in food, shipping and process industries
- Cleaning with foam/water for steam sterilisation
- Able withstand harsh chemicals

Contact Tertech for more product information