

360° ROTATING ORBITAL TANK CLEANERS



PAGE INDEX

1. DG-2
2. DG-5
3. DG-15
4. DG-20
5. DG-30
6. TCM-45
7. MG

PRACTICAL INFO.

Every product is delivered with an assortment of different sized nozzles shown in the performance graphs below each product

READ PRODUCT CODE

MODEL	NUMBER OF NOZZLES	NOZZLE SIZE
D G - 1 5	4	6

IMPORTANT TERMS

HT - High temperatures
F - Explosion proof
OT - Oil tolerant

DG-2 SERIES

360° Orbital Cleaning Nozzle

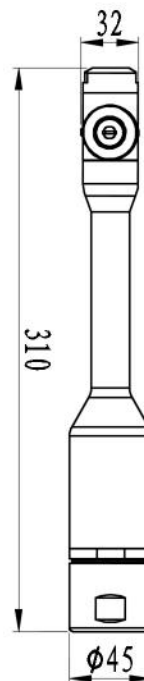

								
3-20c° TEMPERATURE	3-20b PRESSURE	0,5-2m TANK DIAMETER	45mm MIN. HATCH SIZE	2 OR 4 NOZZLES	Ø2-4mm NOZZLE SIZE	1-6m³/h 16-100 L/MIN	3/4" BSPP CONNECTION	2,2kg WEIGHT

DESIGN FEATURES

- High performance, even at low pressure
- Driven and lubricated by the washing fluid
- Driven by integrated gear system
- Mounting angle: Any direction
- Body: 316L SS stainless steel
- Gaskets/bushings: PTFE/PEEK, viton and sanitary composite

SPRAY PATTERN

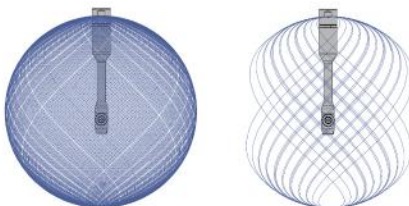

APPLICATION

- 3D ceaning of small containers
- Commonly used in food, shipping and process industries

MODELS

- DG-2-2-2 | DG-2-2-3 | DG-2-2-4
- DG-2-4-2 | DG-2-4-3 | DG-2-4-4
- DG-2-HT - For temperatures up to 250°
- DG-2-F - For lower spark risk
- DG-2-OT - For greater oil resistance

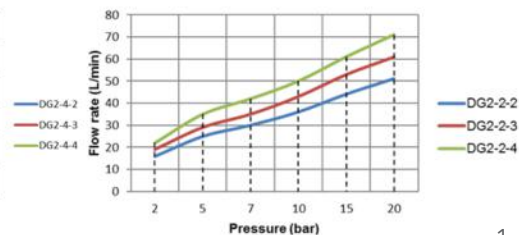
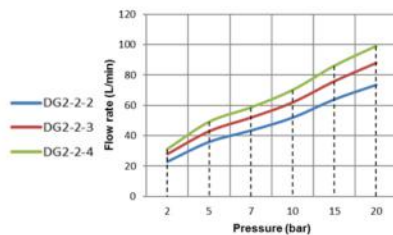
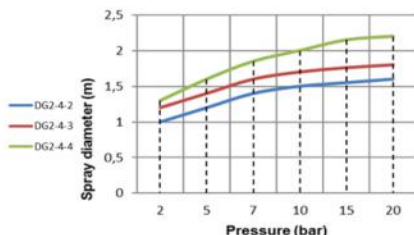
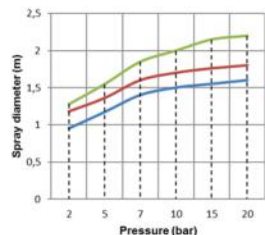

DG-5 SERIES

360° Orbital Cleaning Nozzle

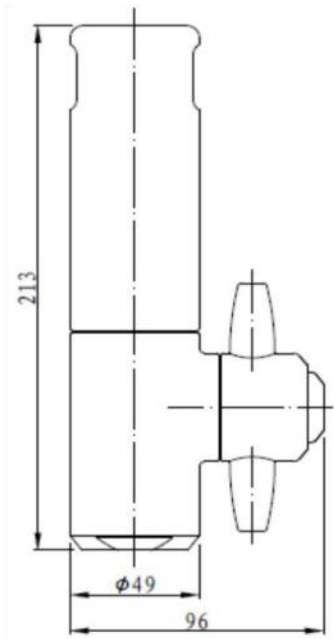

								
3-90° TEMPERATURE	3-30b PRESSURE	0,5-5m TANK DIAMETER	109mm MIN. HATCH SIZE	2 OR 4 NOZZLES	Ø4-6mm NOZZLE SIZE	1,3-10,8-m³/h 22-180 L/MIN	3/4" BSPP CONNECTION	2,6kg WEIGHT

DESIGN FEATURES

- High performance, even at low pressure
- Driven and lubricated by the washing fluid
- Driven by integrated gear system
- Mounting angle: Any direction
- Body: 316L SS stainless steel
- Gaskets/bushings: PTFE/PEEK, viton and sanitary composite

SPRAY PATTERN



APPLICATION

- 3D cleaning of medium containers
- Commonly used in food, shipping and process industries

MODELS

- DG-5-4-4 | DG-5-4-5 | DG-5-4-6
- DG-5-2-4 | DG-5-2-5 | DG-5-2-6
- DG-5-HT - For temperatures up to 250°
- DG-5-F - For lower spark risk
- DG-5-OT - For greater oil resistance
- Long nozzle option

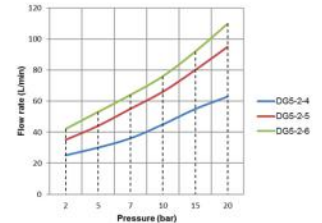
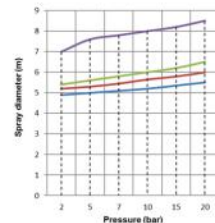
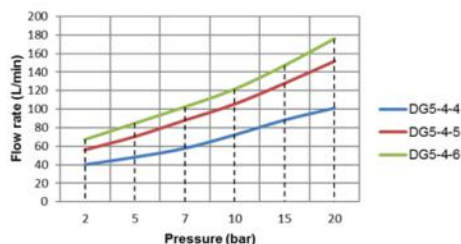
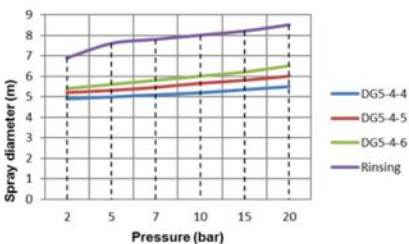

DG-15 SERIES

360° Orbital Cleaning Nozzle

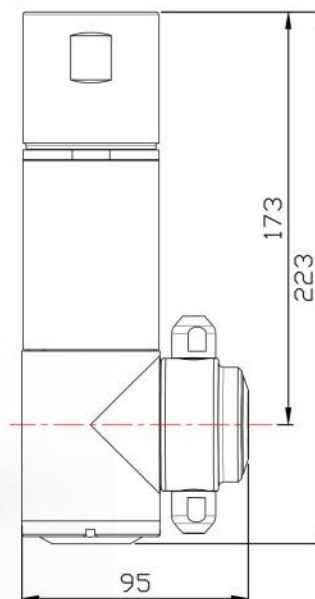

								
3-90° TEMPERATURE	3-20b PRESSURE	0,5-15m TANK DIAMETER	98mm MIN. HATCH SIZE	2,3 OR 4 NOZZLES	Ø6 -8mm NOZZLE SIZE	3-23m³/h 50-375 L/MIN	1 1/2" BSPP CONNECTION	3,3kg WEIGHT

DESIGN FEATURES

- High performance, even at low pressure
- Driven and lubricated by the washing fluid
- Driven by integrated gear system
- Mounting angle: Any direction
- Body: 316L SS stainless steel
- Gaskets/bushings: PTFE/PEEK, viton and sanitary composite

SPRAY PATTERN



APPLICATION

- 3D cleaning of large containers
- Commonly used in food, shipping and process industries

MODELS

- DG-15-4-6 | DG-15-4-8
- DG-15-2-6 | DG-15-2-8
- DG-15-HT - For temperatures up to 250°
- DG-15-F - For lower spark risk
- DG-15-OT - For greater oil resistance
- Long nozzle option

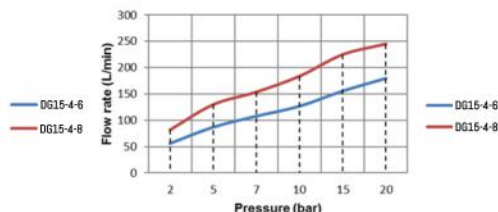
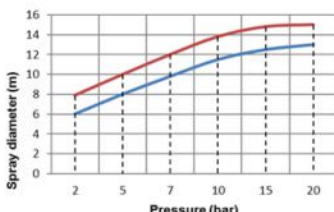
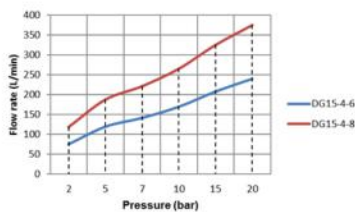
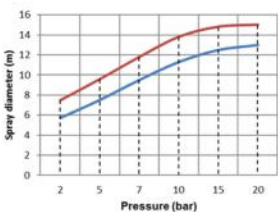

DG-20 SERIES

360° Orbital Cleaning Nozzle

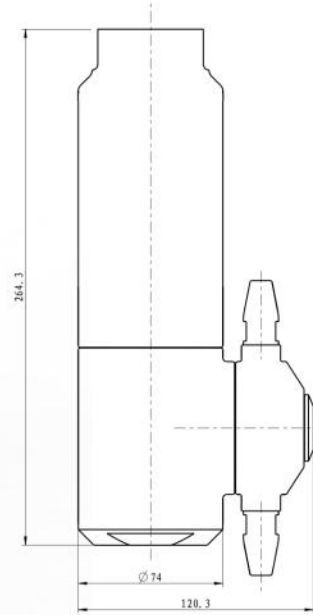

								
3-95° TEMPERATURE	3-20b PRESSURE	0,5-20m TANK DIAMETER	157mm MIN. HATCH SIZE	2 OR 4 NOZZLES	Ø6-10mm NOZZLE SIZE	4,2-15m³/h 70-250 L/MIN	1 1/2" BSPP CONNECTION	6,3kg WEIGHT

DESIGN FEATURES

- High performance, even at low pressure
- Driven and lubricated by the washing fluid
- Driven by integrated gear system
- Mounting angle: Vertically, facing down
- Body: 316L SS stainless steel
- Gaskets/bushings: PTFE/PEEK, viton and sanitary composite

SPRAY PATTERN

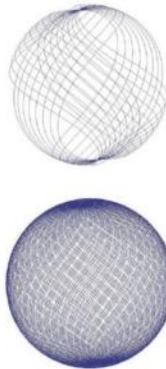

APPLICATION

- 3D cleaning of large containers
- Commonly used in food, shipping and process industries

MODELS

- DG-20-4-6 | DG-20-4-7 | DG-20-4-8 | DG-20-4-10
- DG-20-2-6 | DG-20-2-7 | DG-20-2-8 | DG-20-2-10
- DG-20-HT - For temperatures up to 250°
- DG-20-F - For lower spark risk
- DG-20-OT - For greater oil resistance
- Long nozzle option

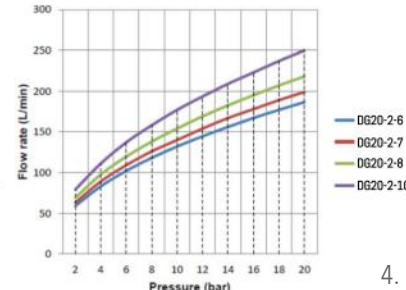
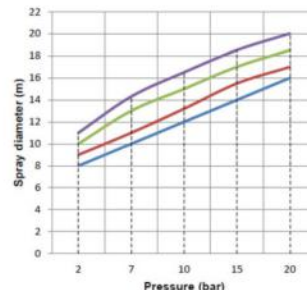
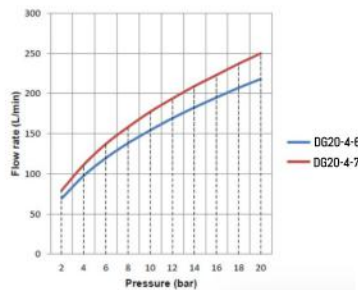
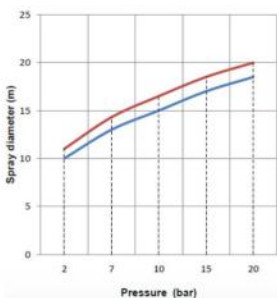

DG-30 SERIES

360° Orbital Cleaning Nozzle

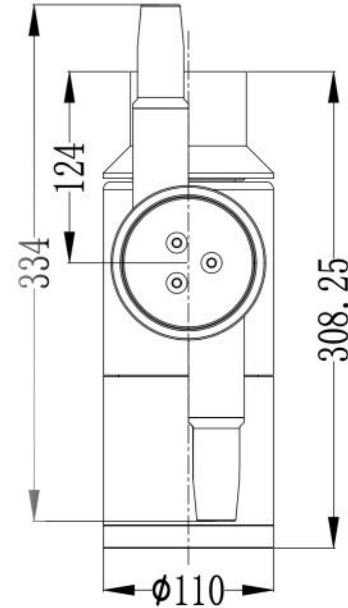

								
3-120c° TEMPERATURE	3-30b PRESSURE	0,5-30m TANK DIAMETER	185mm MIN. HATCH SIZE	2 NOZZLES	Ø8-16mm NOZZLE SIZE	7-55m³/h 120-910 L/MIN	2" BSPP FR CONNECTION	18,5kg WEIGHT

DESIGN FEATURES

- High performance, even at low pressure
- Driven and lubricated by the washing fluid
- Driven by integrated gear system
- Mounting angle: Any direction
- Body: 316L SS stainless steel
- Gaskets/bushings: PTFE/PEEK, viton and sanitary composite

SPRAY PATTERN

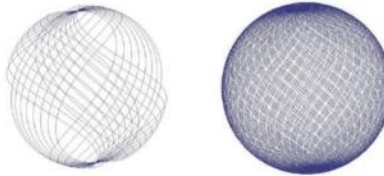

APPLICATION

- 3D cleaning of large containers
- Commonly used in food, shipping and process industries

MODELS

- DG-30-2-8 | DG-30-2-10
- DG-30-2-12 | DG-30-2-16
- DG-30-HT - For temperatures up to 250°
- DG-30-F - For lower spark risk
- DG-30-OT - For greater oil resistance
- Long nozzle option

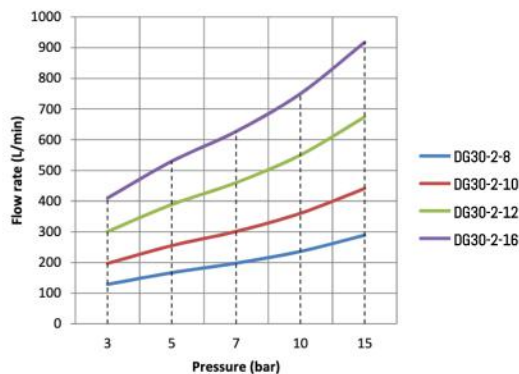
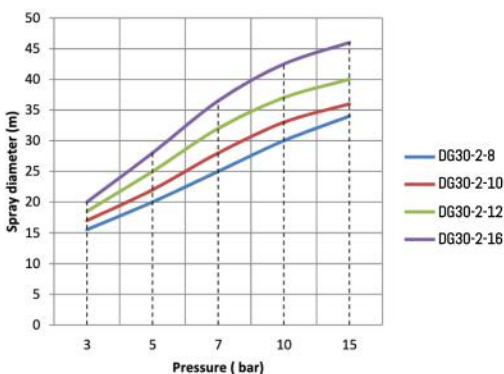

TCM-45 SERIES

360° Orbital Cleaning Nozzle

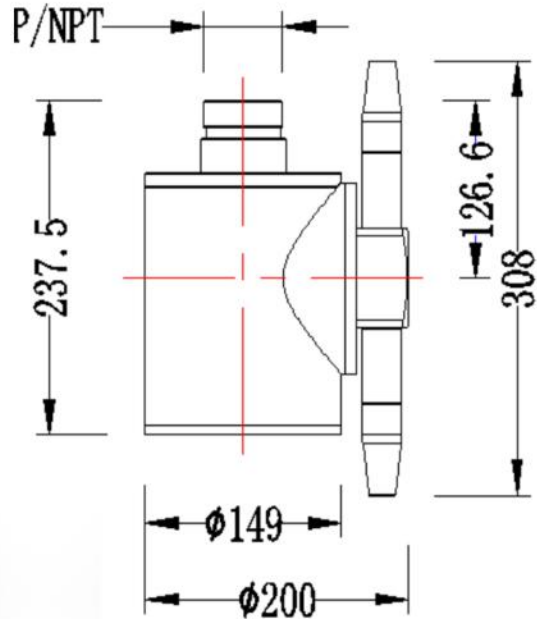

								
3-150c° TEMPERATURE	3-20b PRESSURE	0,5-45m TANK DIAMETER	385mm MIN. HATCH SIZE	2 NOZZLES	Ø9-12mm NOZZLE SIZE	9,6-30m³/h 160-500 L/MIN	2" BSPP CONNECTION	19kg WEIGHT

DESIGN FEATURES

- High performance, even at low pressure
- Driven and lubricated by the washing fluid
- Driven by integrated gear system
- Mounting angle: Any direction
- Body: 316L SS stainless steel
- Gaskets/bushings: PTFE/PEEK, viton and sanitary composite

SPRAY PATTERN

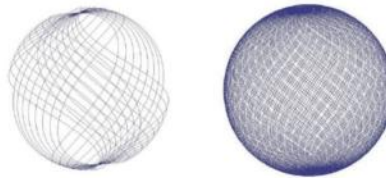

APPLICATION

- 3D cleaning of large containers
- Commonly used in food, shipping and process industries

MODELS

- TMC-45-2-9 | TMC-45-2-10
- TMC-45-2-11 | TMC-45-2-12

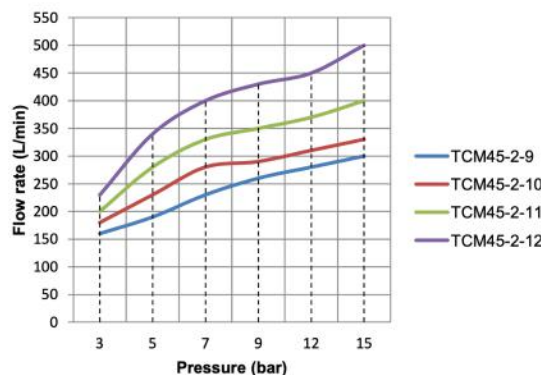
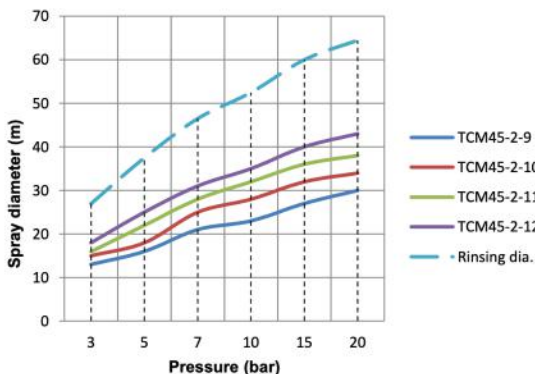

MG SERIES

360° Orbital Cleaning Nozzle

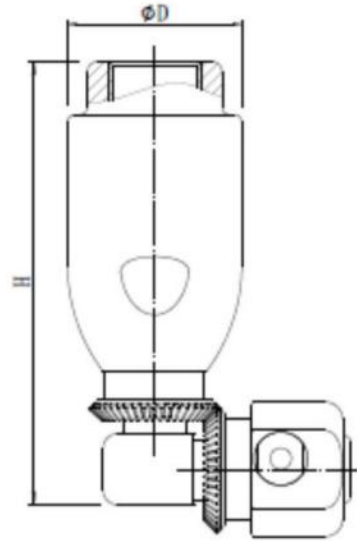

								
3-95° TEMPERATURE	3-20b PRESSURE	2-10m TANK DIAMETER	39-110mm MIN. HATCH SIZE	2 NOZZLES	Ø2-8mm NOZZLE SIZE	0,7-9,6m³/h 18-450 L/MIN	1/2" 3/4" BSPP CONNECTION	2-2,35kg WEIGHT

DESIGN FEATURES

- High performance, even at low pressure
- Driven and lubricated by the washing fluid
- Driven by integrated gear system
- Mounting angle: Any direction
- Body: 316L SS stainless steel
- Gaskets/bushings: PTFE/PEEK, viton and sanitary composite

SPRAY PATTERN

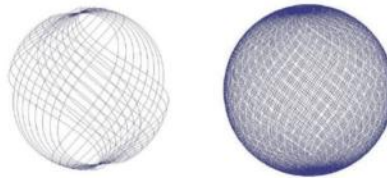

APPLICATION

- 3D cleaning of medium to small containers
- Commonly used in food, shipping and process industries

MODELS

- MG-2 | MG-5 | MG-8
- MG-HT - For temperatures up to 250°
- MG-F - For lower spark risk
- MG-OT - For greater oil resistance

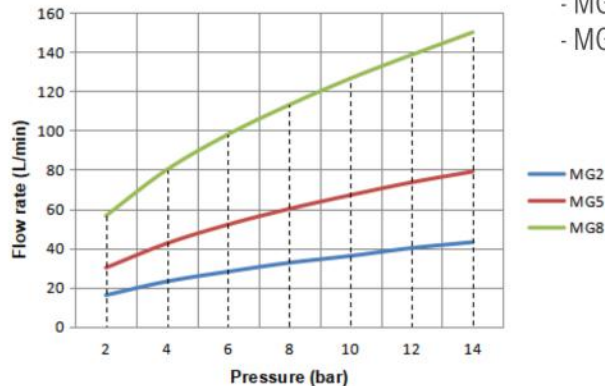
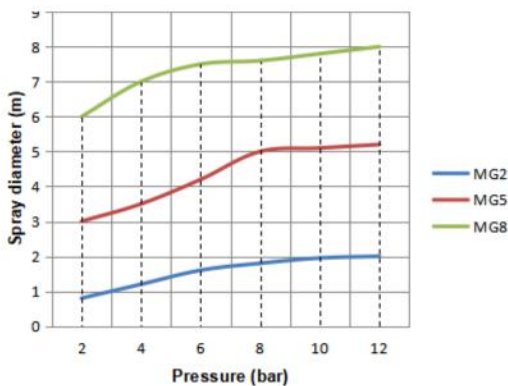

TerTech tank cleaning systems

DG15-L-3D series

360° Orbital cleaning nozzle

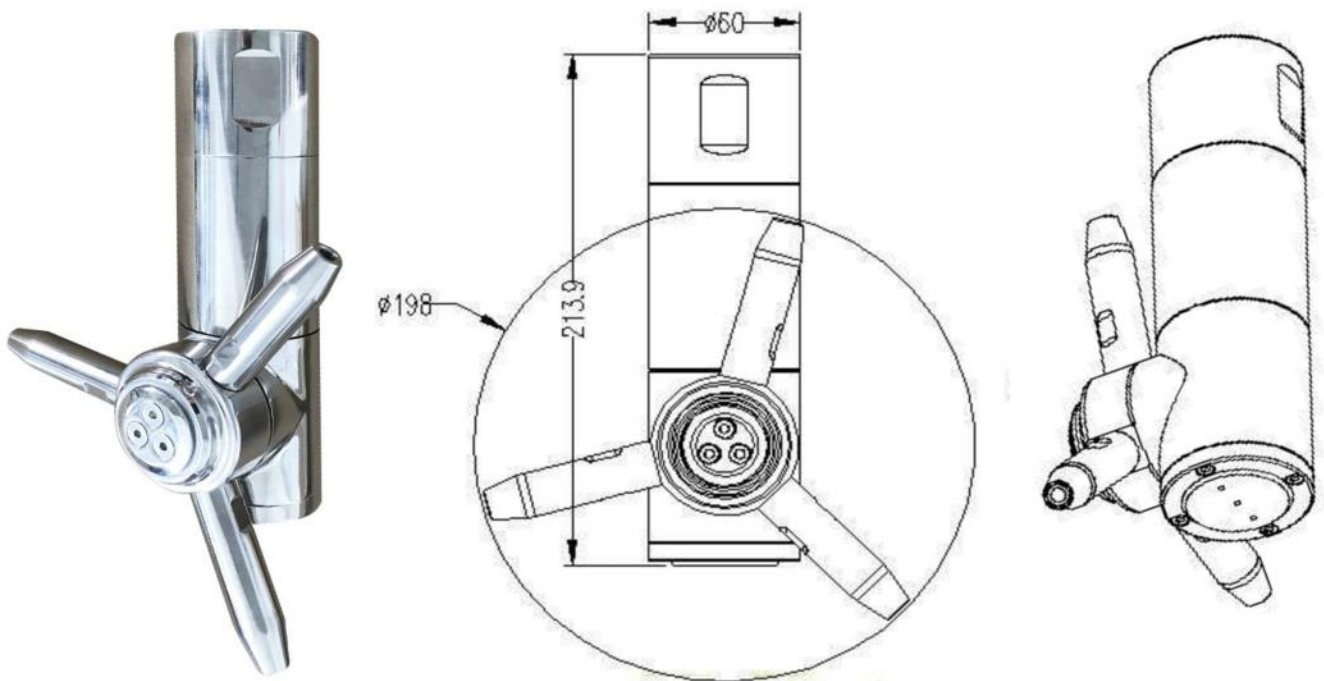

Cleaning process simulation:



First circle

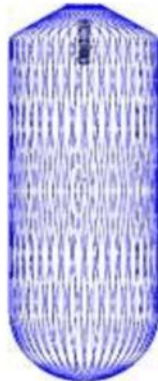

Full pattern

Ordering info:

DG15 -L-3-6- 360° - 316LSS - 1 1/2"-FR

Model - angle Material Connection

